

1	2	3	4	5	6	7	8	9	10
main power switch	exhaust fan	supply fan							

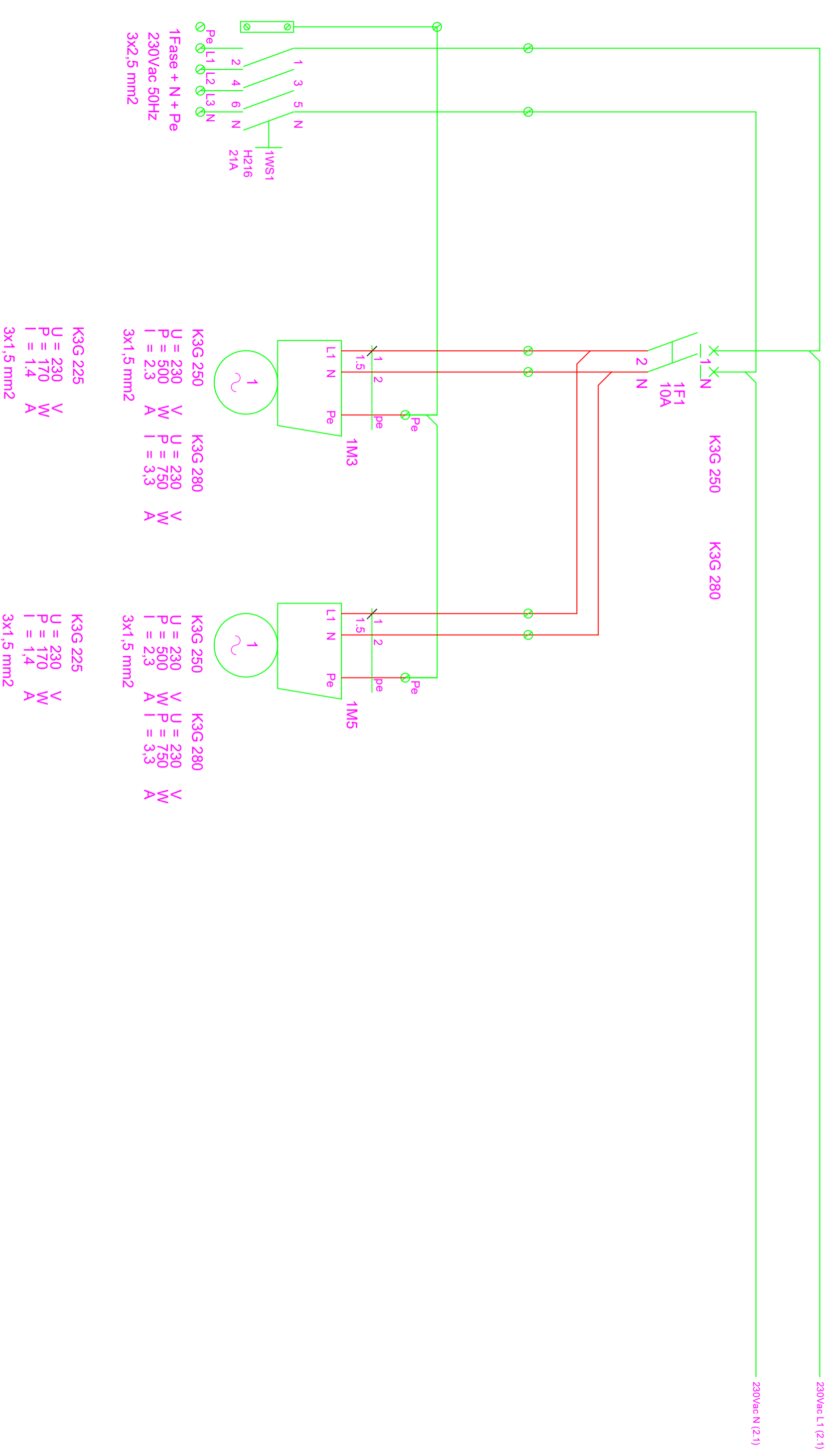

①	
②	
③	

Get.	HMV
Datum	8-9-2020

Order Type	OJ Air2 master
Rev.	5
status	-

Page discription	power supply 230V - 230V
------------------	--------------------------

	1	2	3	4	5	6	7	8	9	10
				powersupply Trafo		powersupply OJ Air2 AHC 3000		powersupply OJ Air2 DRHX 1120 rotor controller		

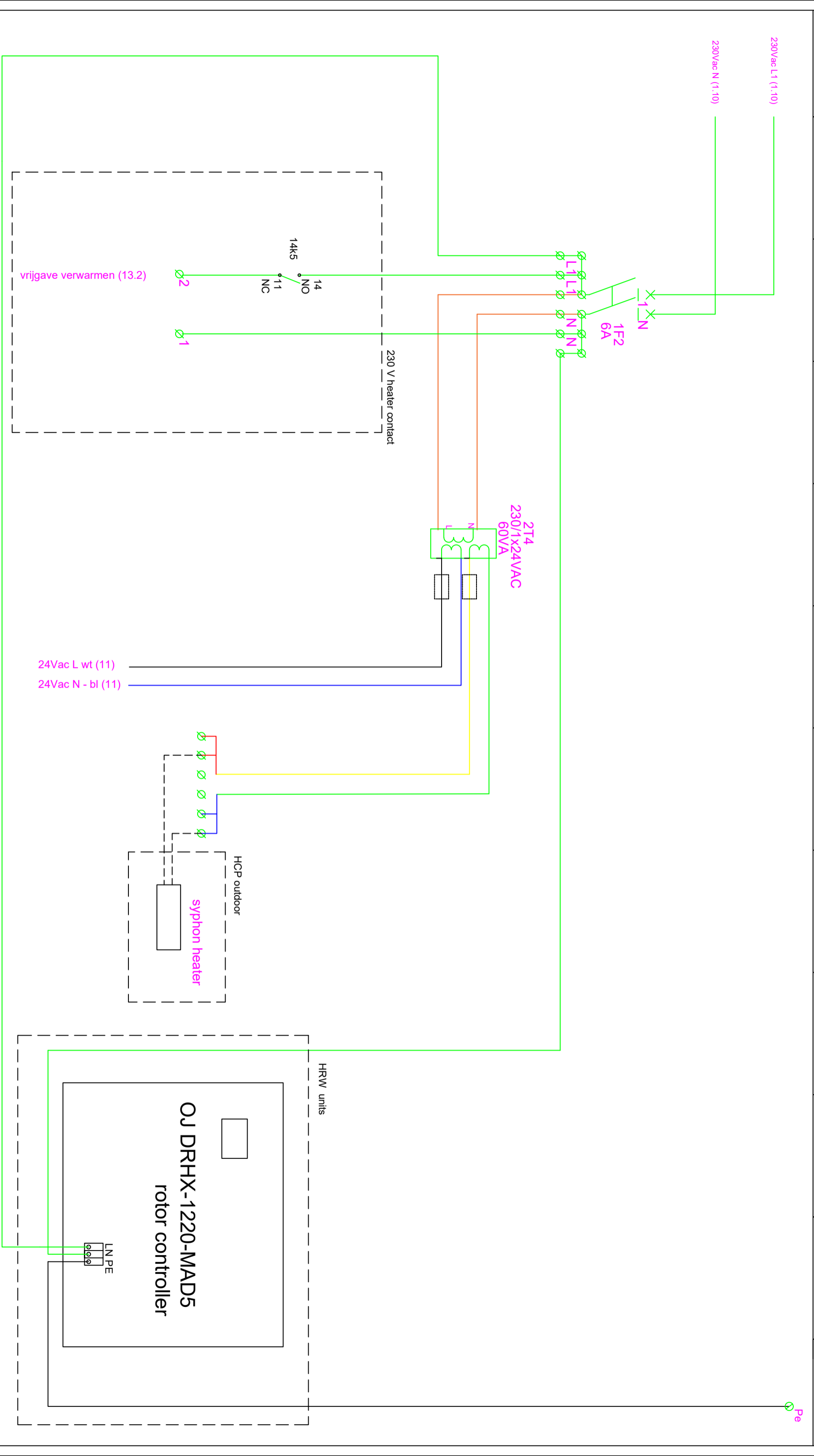

Get.	HMV	Order	OJ Air2 master	Page description	Powersupply 24VAC	Page : 03
Datum	8-9-2020	Type	5	Rev.		
	-	Rev.	-	status		

1	2	3	4	5	6	7	8	9	10	power controller
Din 1 Alarm supply fan	Din2 Alarm extract fan	Din3 start/stop contact	Din4 Fire contact	Din5 High Speed						

24Vac L wI (11)
24Vac N - bl (11)

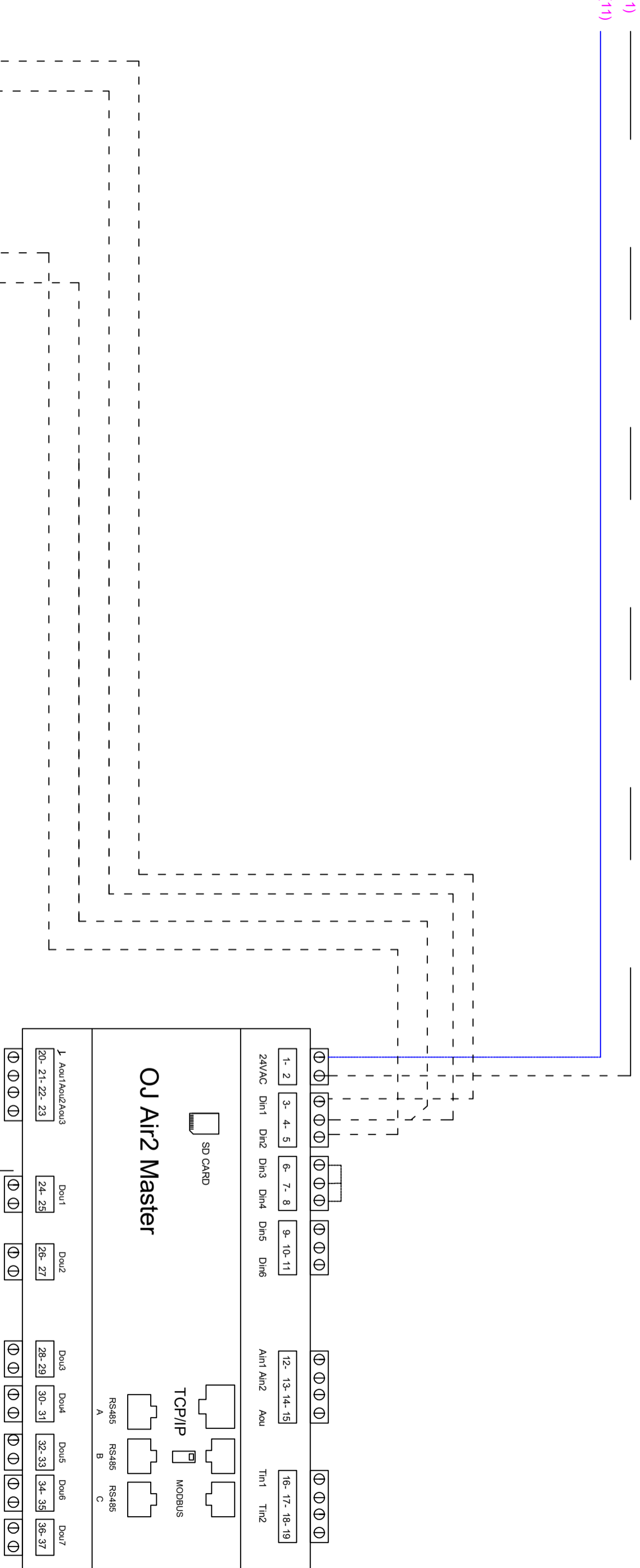

①	
②	
③	

Get.	HMV
Datum	8-9-2020
-	-

Order Type	OJ Air2 master
Rev.	5
status	-

Page description	Digital in
------------------	------------

Blz: 11

1	AI1 CO2 sensor	2	AI2 VOC sensor	3	4	5	6	7	8	9	10

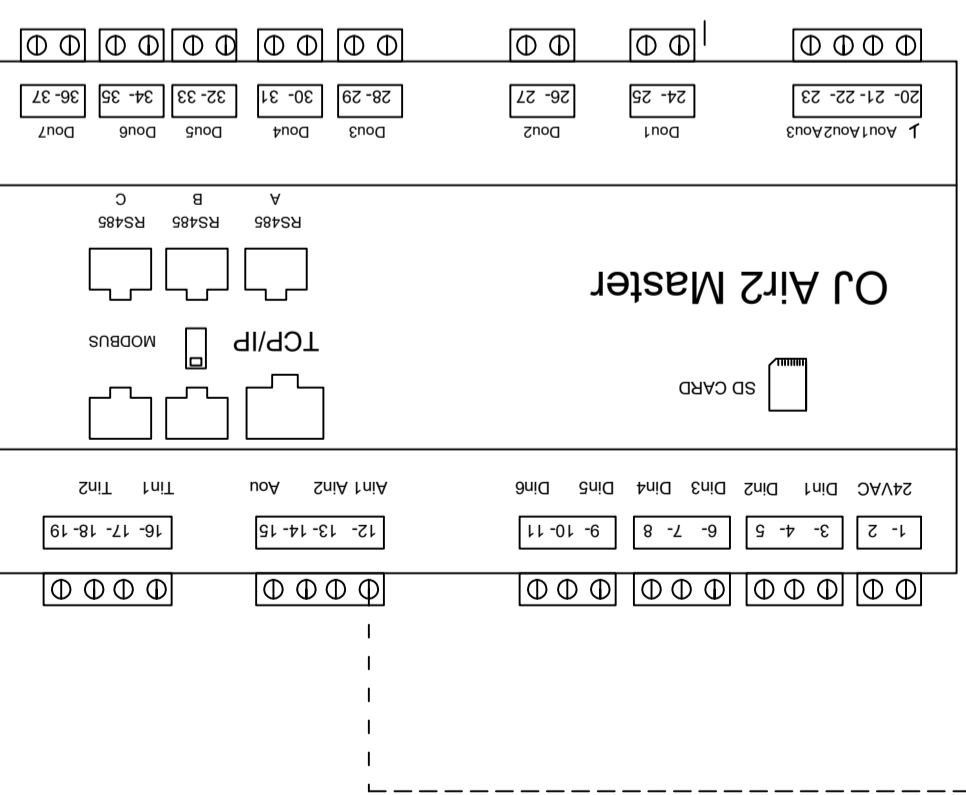
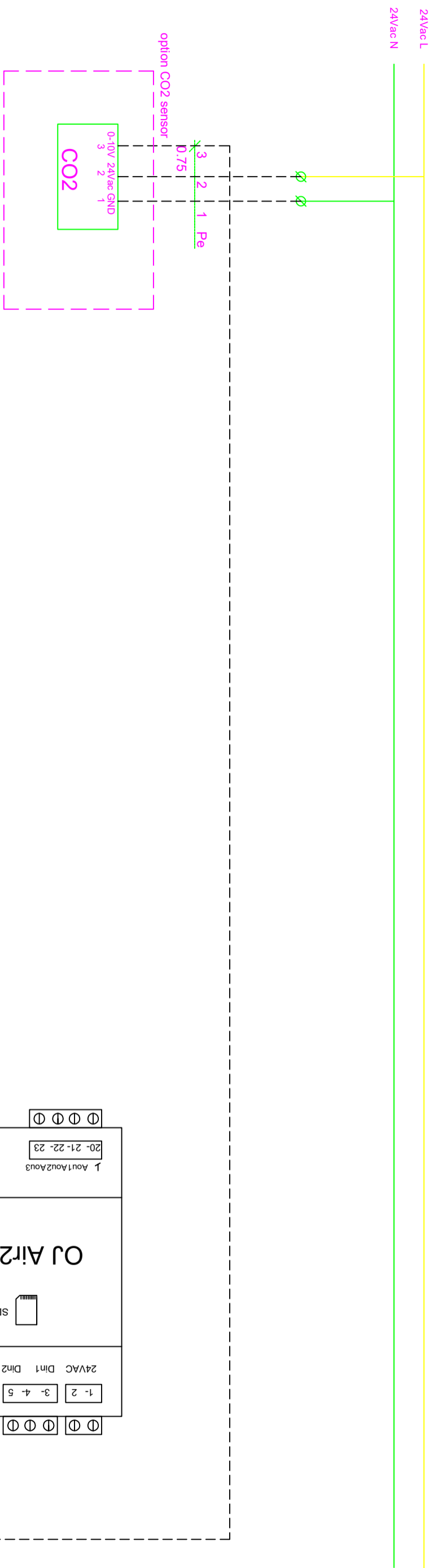

Get. Datum	JMV	8-9-2020	Order Type	OJ Air2 master	Page description	Analog in	Blz:	12
Rev.	-	-	Rev.	5				
status	-	-	status	-				
①			②					
③			④					

1	AO 1	heating (HP)	EXT modul
2	AO2	Cooling	EXT modul
3			
4	AO 1	bypass HCP	
5	AO 2	extract fan	
6	AO 3	supply fan	
7			
8			
9			
10			

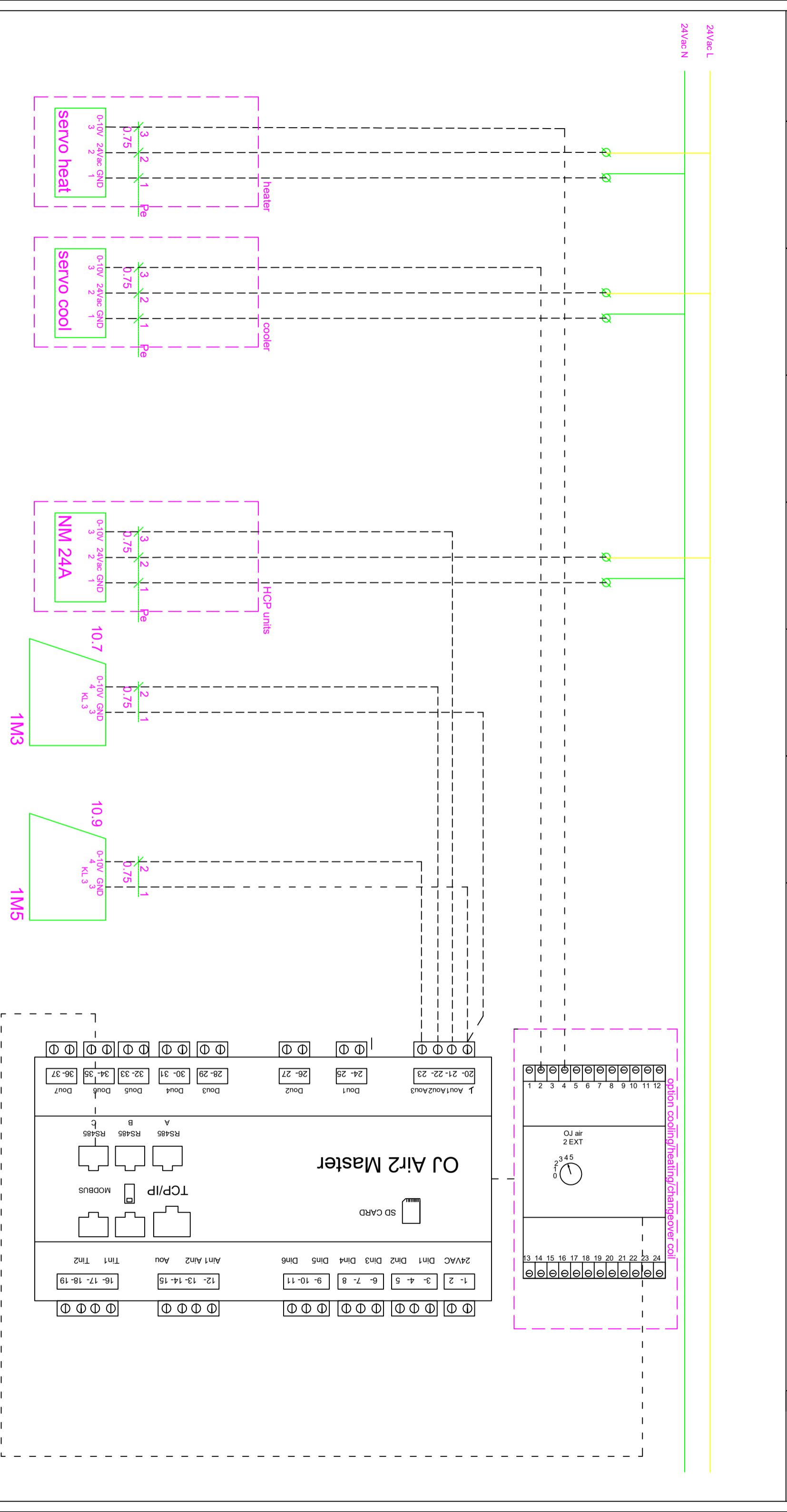

①	Get.	HMV	Order	Page description	Blz:	13
②	Datum	8-9-2020	Type	Analogue out		
③			Rev.			
④			status			
⑤						

1	2	3	4	5	6	7	8	9	10
DO1	DO2			DO1	DO2	DO3	DO4	DO5	DO6
heating (HP) EXT modul	cooling (HP) EXT modul			(EXT) Damper contact	heating relay	A alarm	B alarm	Operating	
13/14	15/16				(Pumpswitch)	contact	contact	relay	

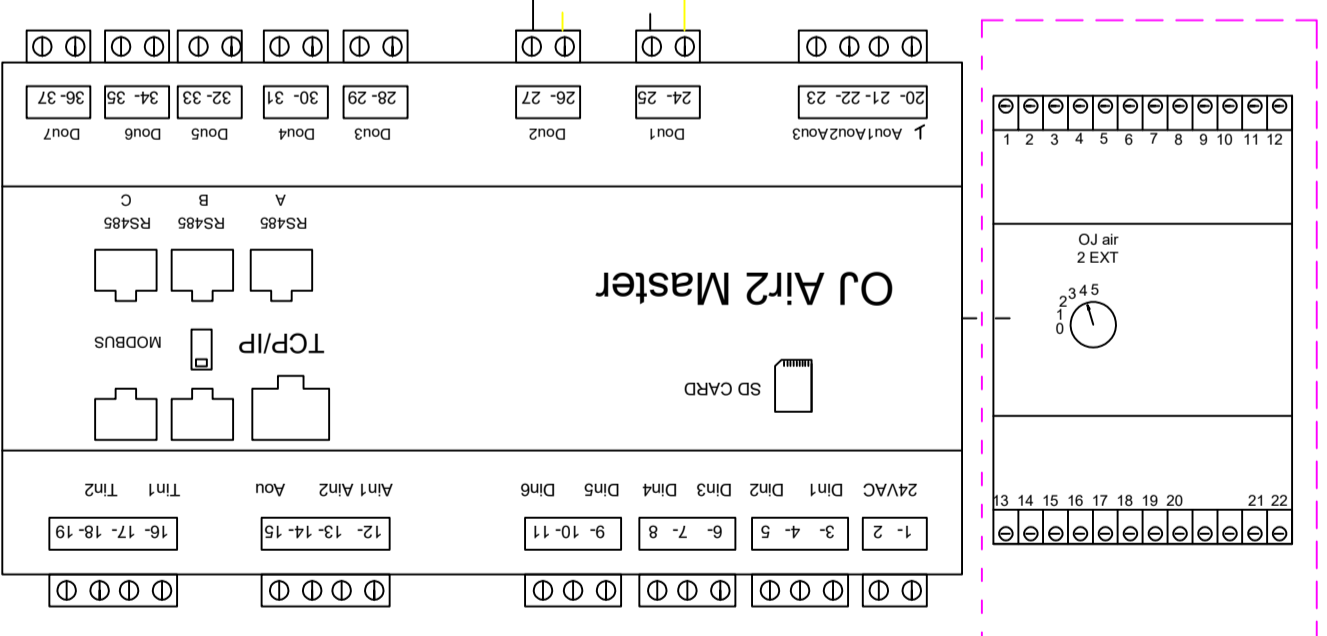
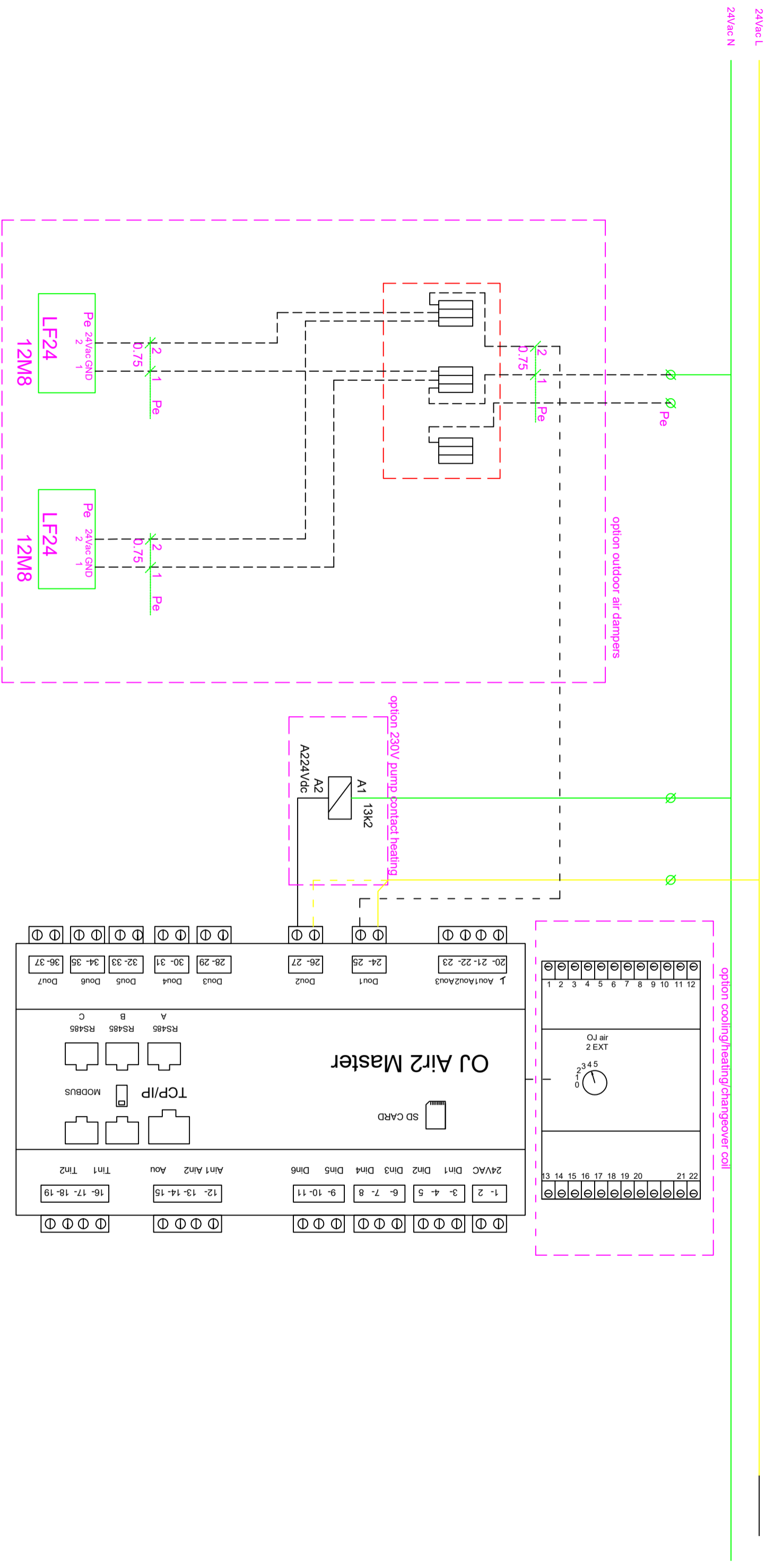

①	
②	
③	

Get.	HMV
Datum	8-9-2020

Order Type	OJ Air2 master
Rev.	5
status	-

Page description	Digital out
------------------	-------------

Blz: 14

1	2	3	4	5	6	7	8	9	10
sensor supply	sensor extract	sensor outside	sensor exhaust	sensor frostprotect	sensor room				
T11	T12	T13	T14	T15	T16				

HCP

24Vac L
24Vac N

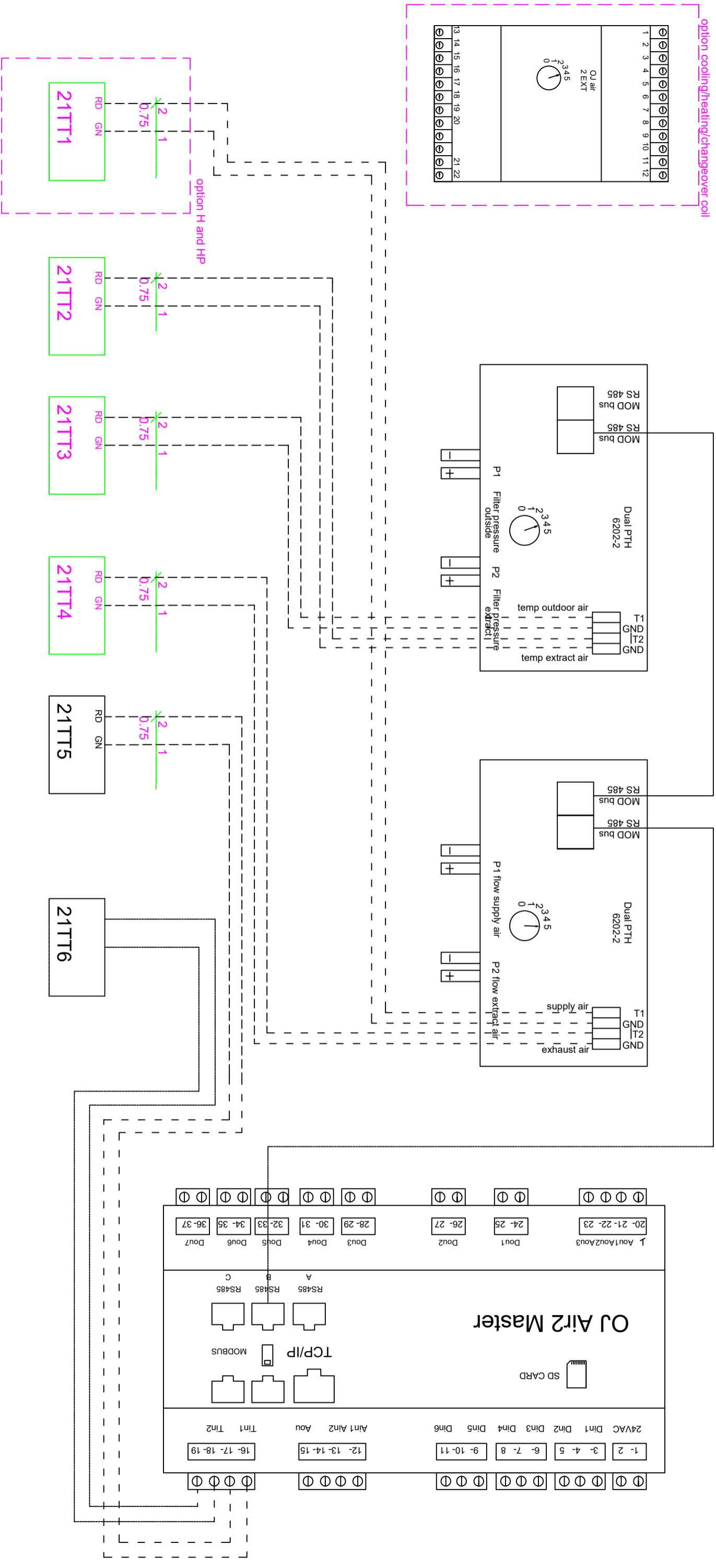

Get.	HMV	Order Type	OJ Air2 master	Page description	temperature and pressure connections with flow control
Datum	8-9-2020	Rev.	5		
		status	-		

Blz: **21**

1	2	3	4	5	6	7	8	9	10
sensor supply prio 1,2	sensor extract	sensor outside	sensor exhaust	sensor frost	sensor room				
T11	T12	T13	T14	T15	T16				

HRW/HCP Iying

24Vac L
24Vac N

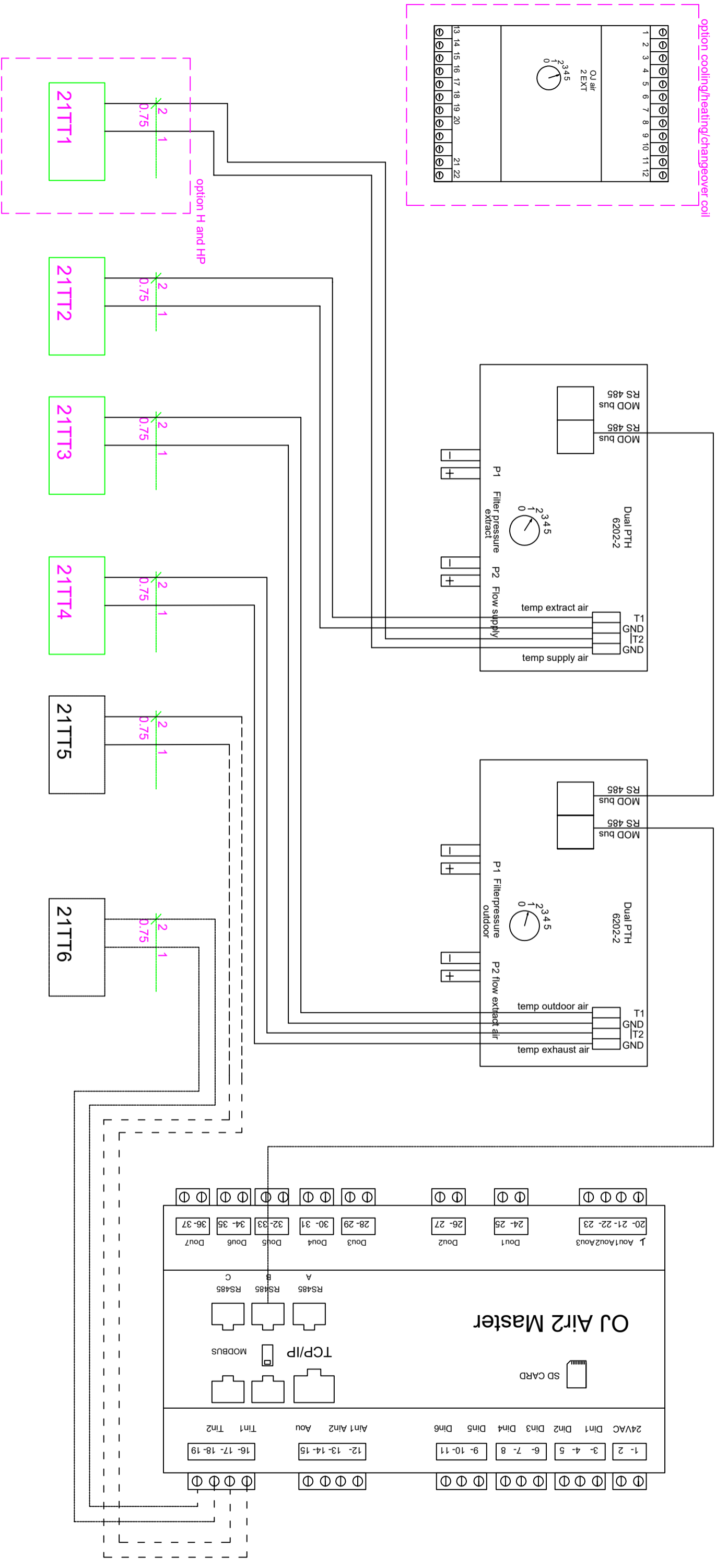

Get.	HMV	Order Type	OJ Air2 master	Page description	temperature and pressure connections with flow control
Datum	8-9-2020	Rev.	5		
		status	-		
				Blz:	22

1	2	3	4	5	6	7	8	9	10
sensor supply	sensor extract	sensor outside	sensor exhaust	sensor frostprotect	sensor room				
T11	T12	T13	T14	T15	T16				

HCP 600/800

24Vac L
24Vac N

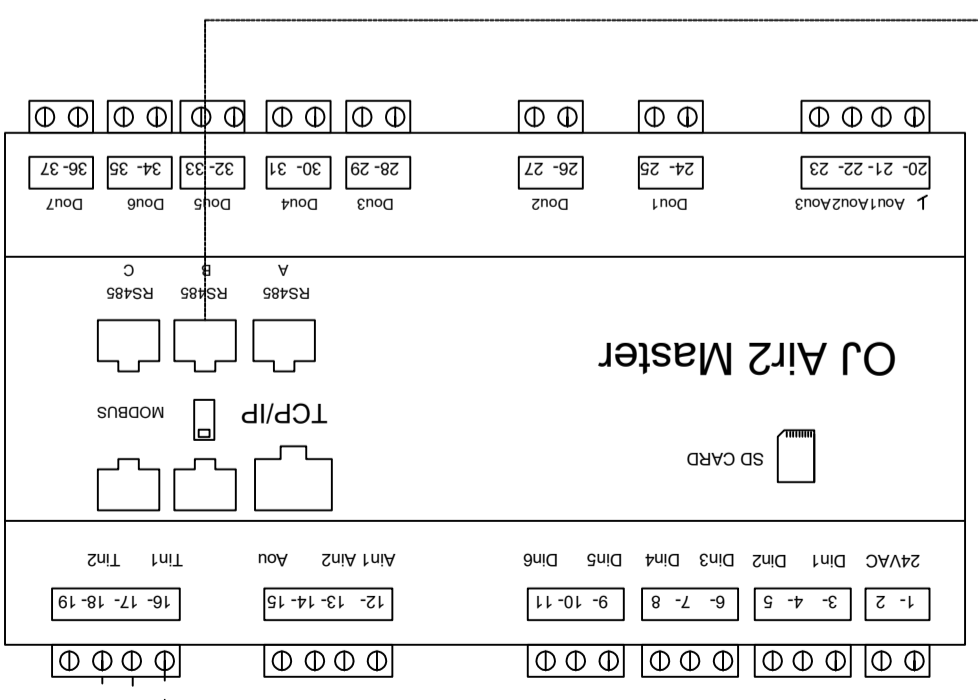
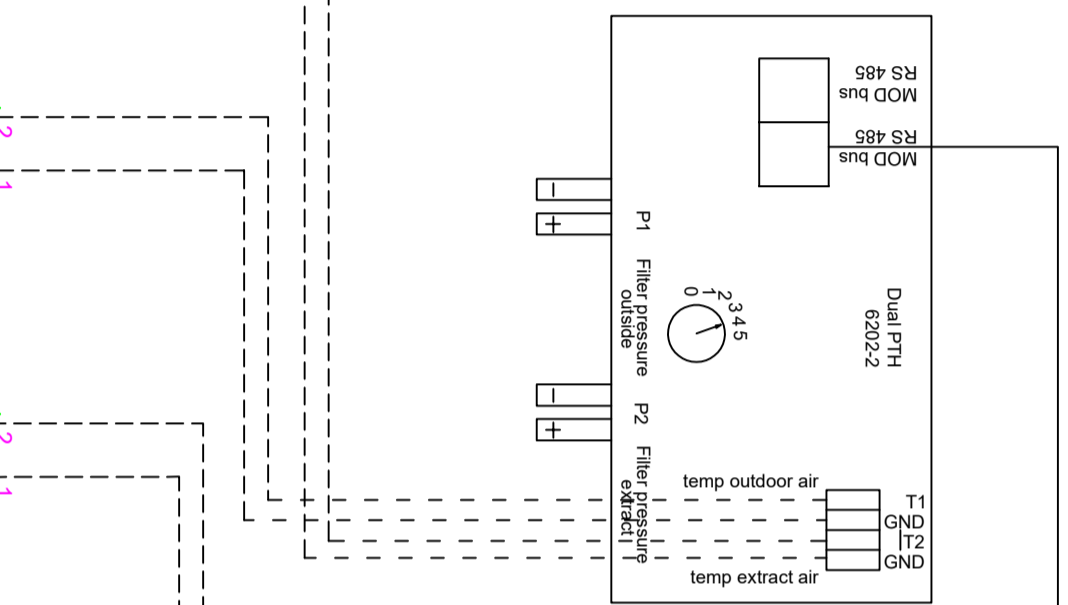
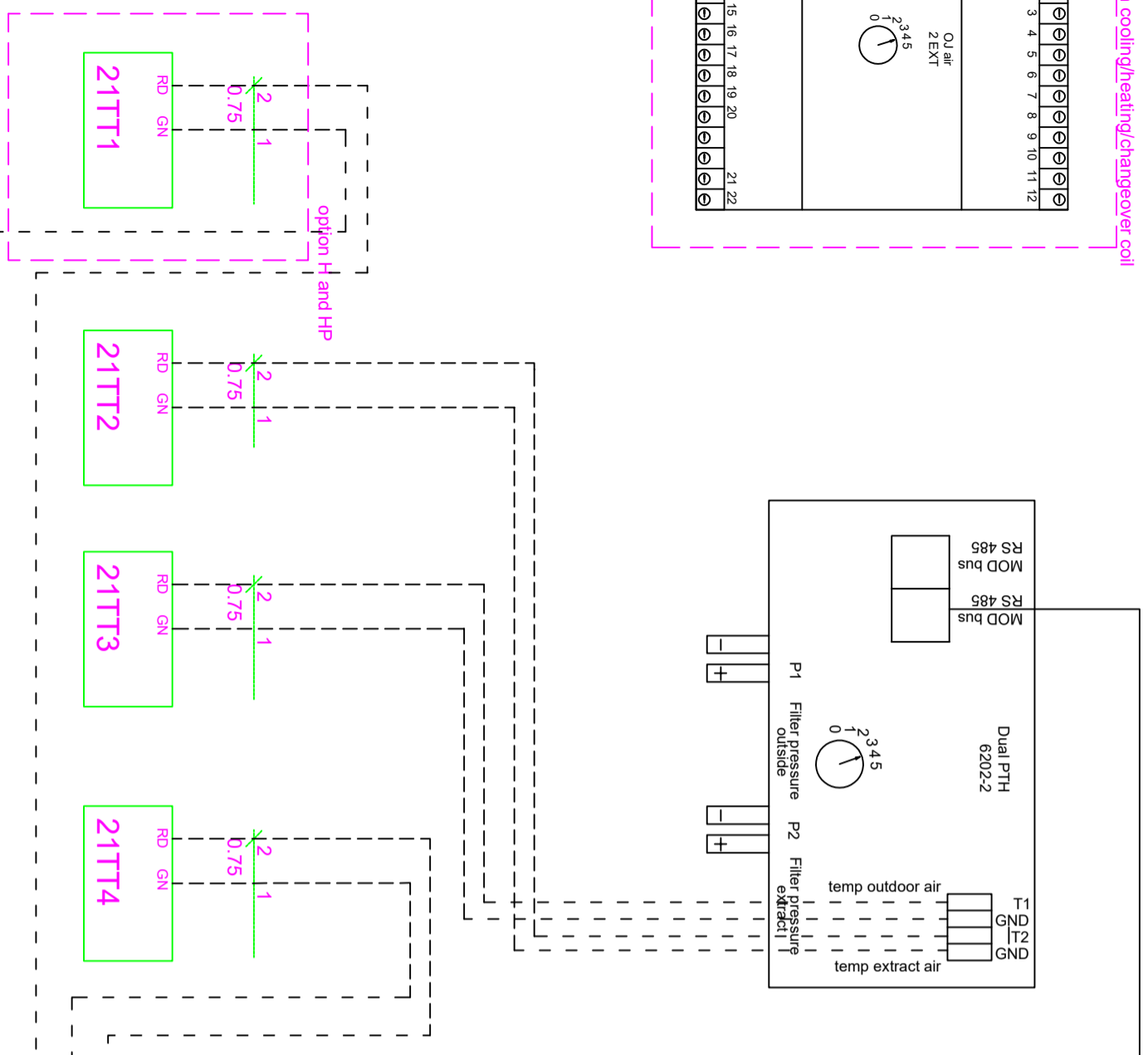
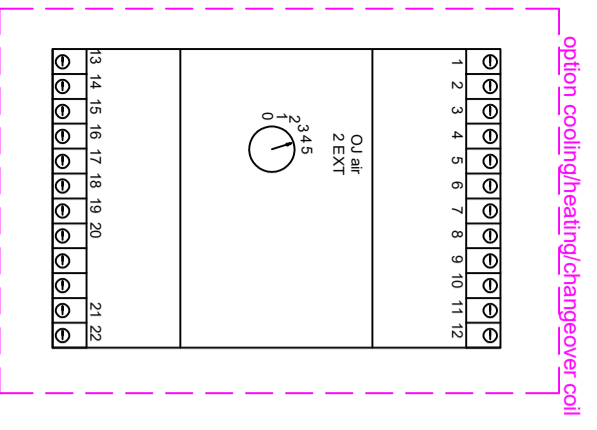

Get.	HMV	Order Type	OJ Air2 master	Page description	temperature and pressure connections with flow control	Blz:	23
Datum	8-9-2020	Rev.	5				
		status	-				

1	2	3	4	5	6	7	8	9	10
							powersupply		
							OJ Air2		
							DRHX 1120		
							rotor controller		

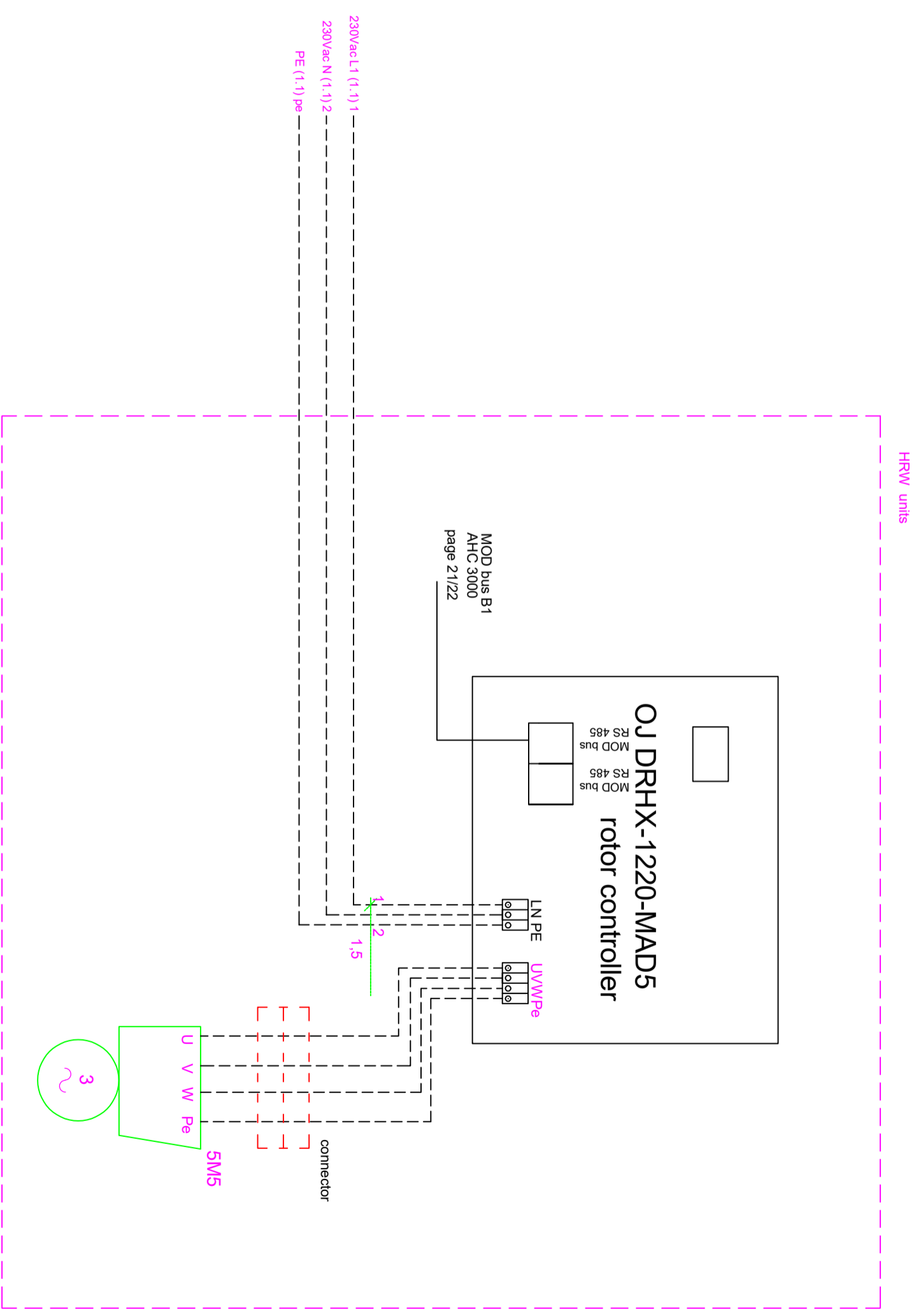

①	
②	
③	

Get.	HMV
Datum	8-9-2020
Datum	-

Order	OJ Air2 master
Type	5
Rev.	-
status	-

OJ DRHX 1120 MAD 5
rotor controller

Blz: **24**

1	2	3	4	5	6	7	8	9	10
					duct pressure	duct pressure			
					supply air	extract air			
					PTH 6202	PTH 6202			
					6	7			

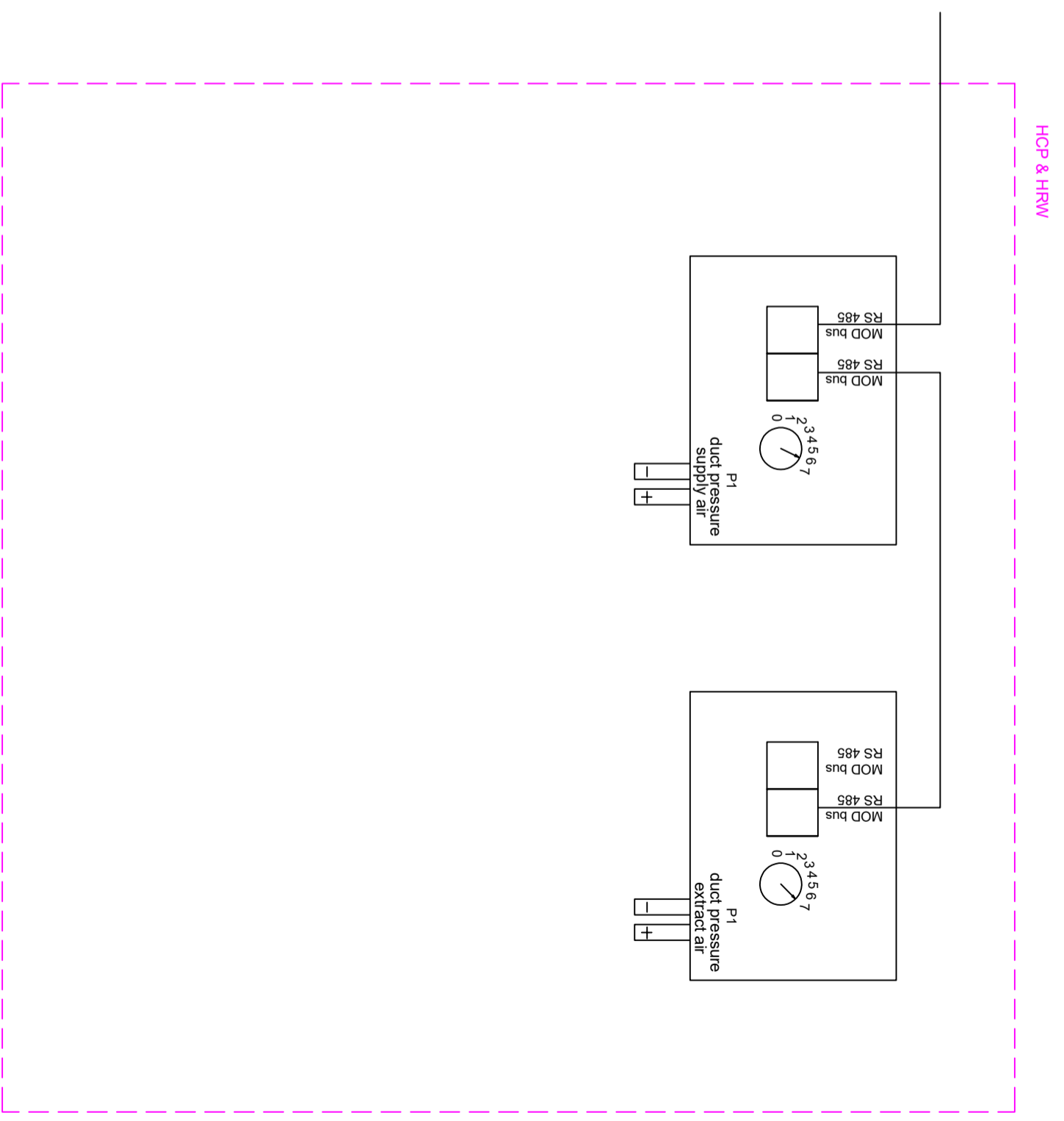

①	Get.	HMV
②	Datum	8-9-2020
③	Datum	-

Order Type	Order
Rev. status	Rev. status
5	5
-	-
OJ Air2 master	

PTH 6202
pressure controlled supply and extract

Blz: **25**

Touchscreen

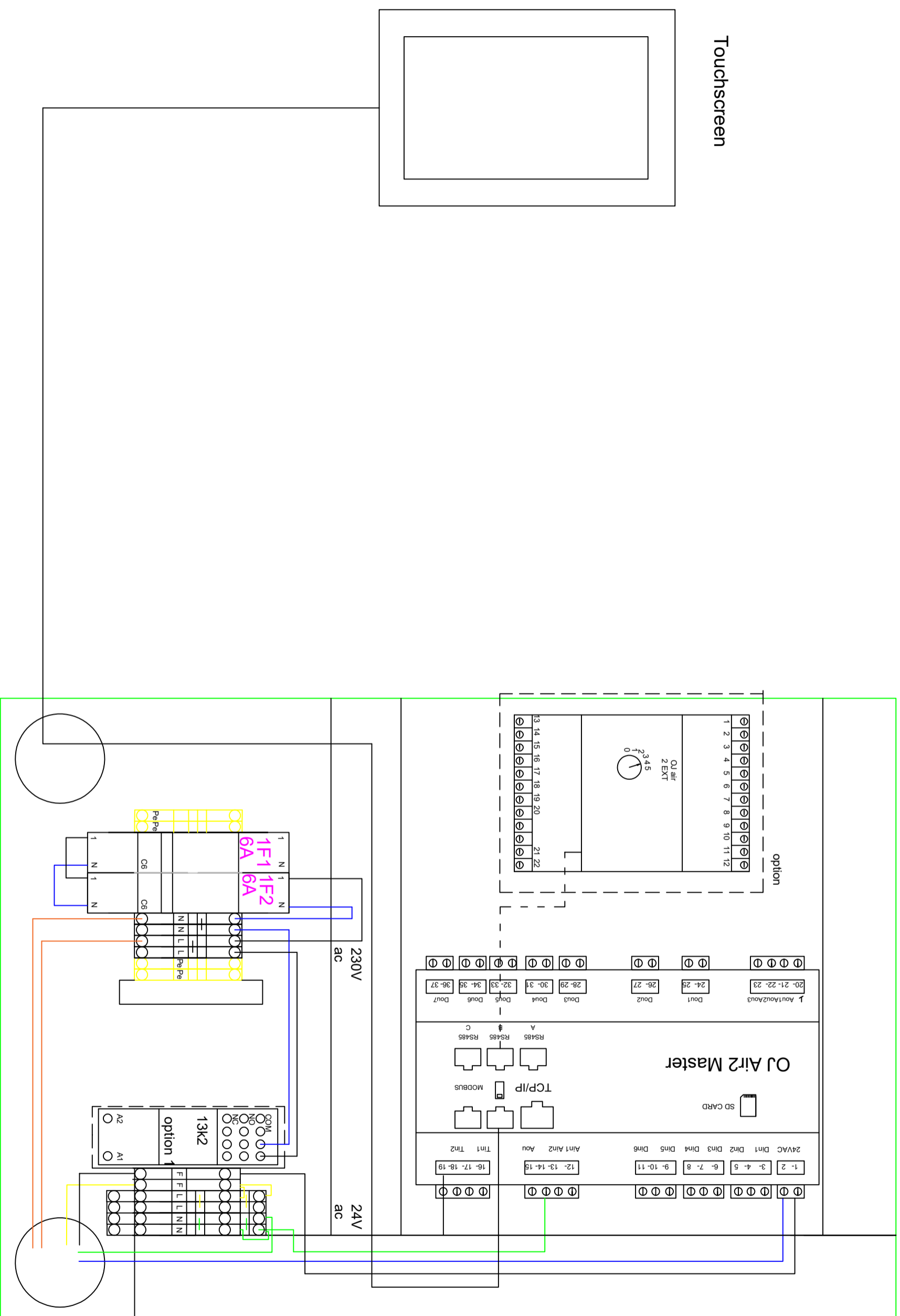

Get.	HMV
Datum	8-9-2020
	-
	-

Order Type	OJ Air2 master
Rev.	5
status	-

Page description
cabinet drawing & display connection 230V

Blz: 50

①	
②	
③	

1

2

3

4

5

6

7

8

9

10

Touchscreen

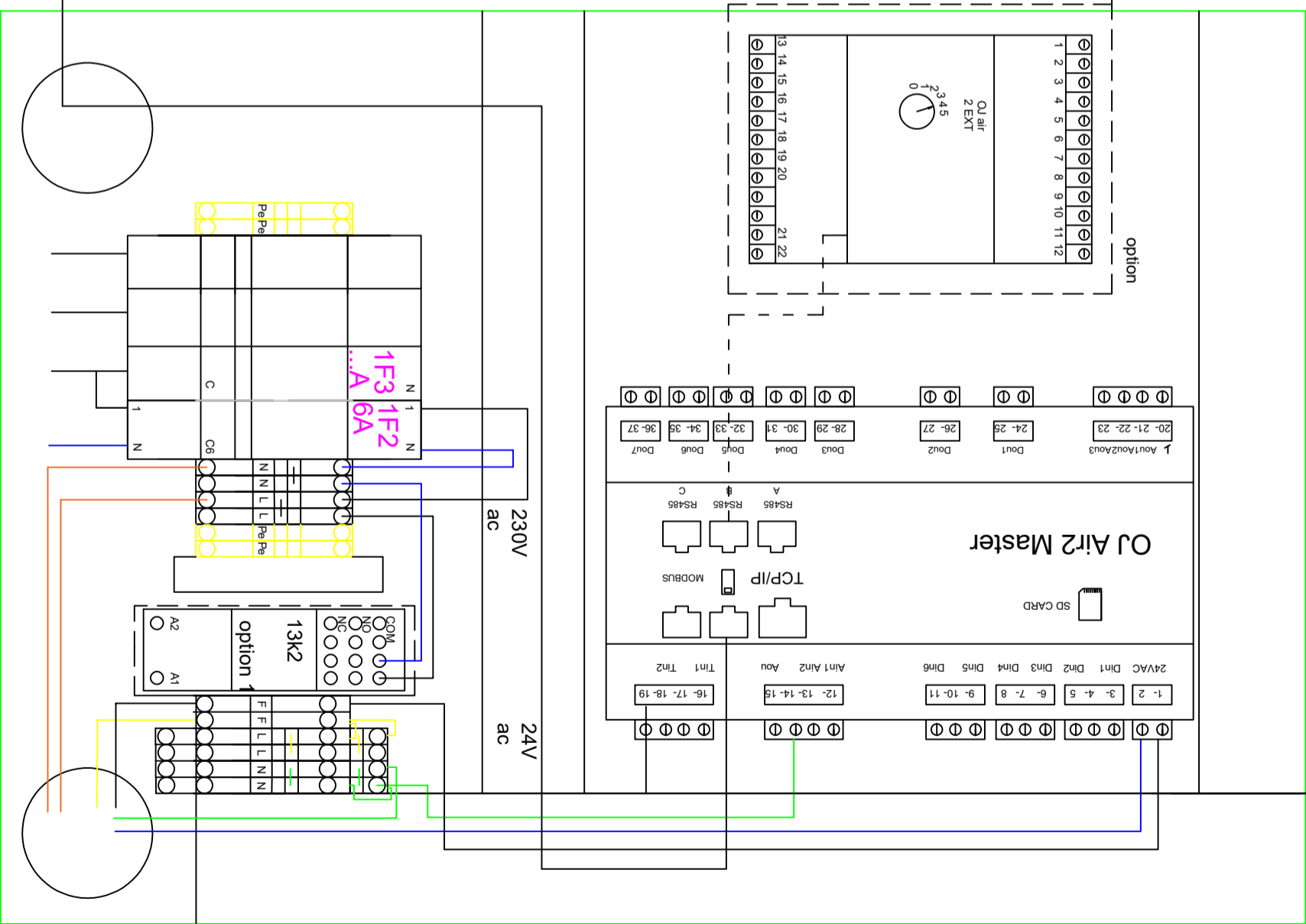
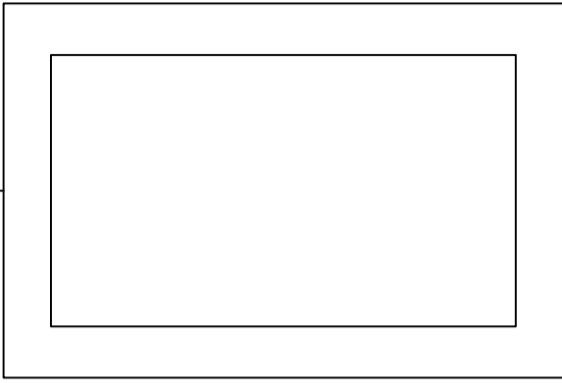

Get.	HMV
Datum	8-9-2020
-	-
-	-

Order	OJ Air2 master
Type	5
Rev.	-
status	-

Page discription
cabinet drawing & display connection 400V

Blz: **51**

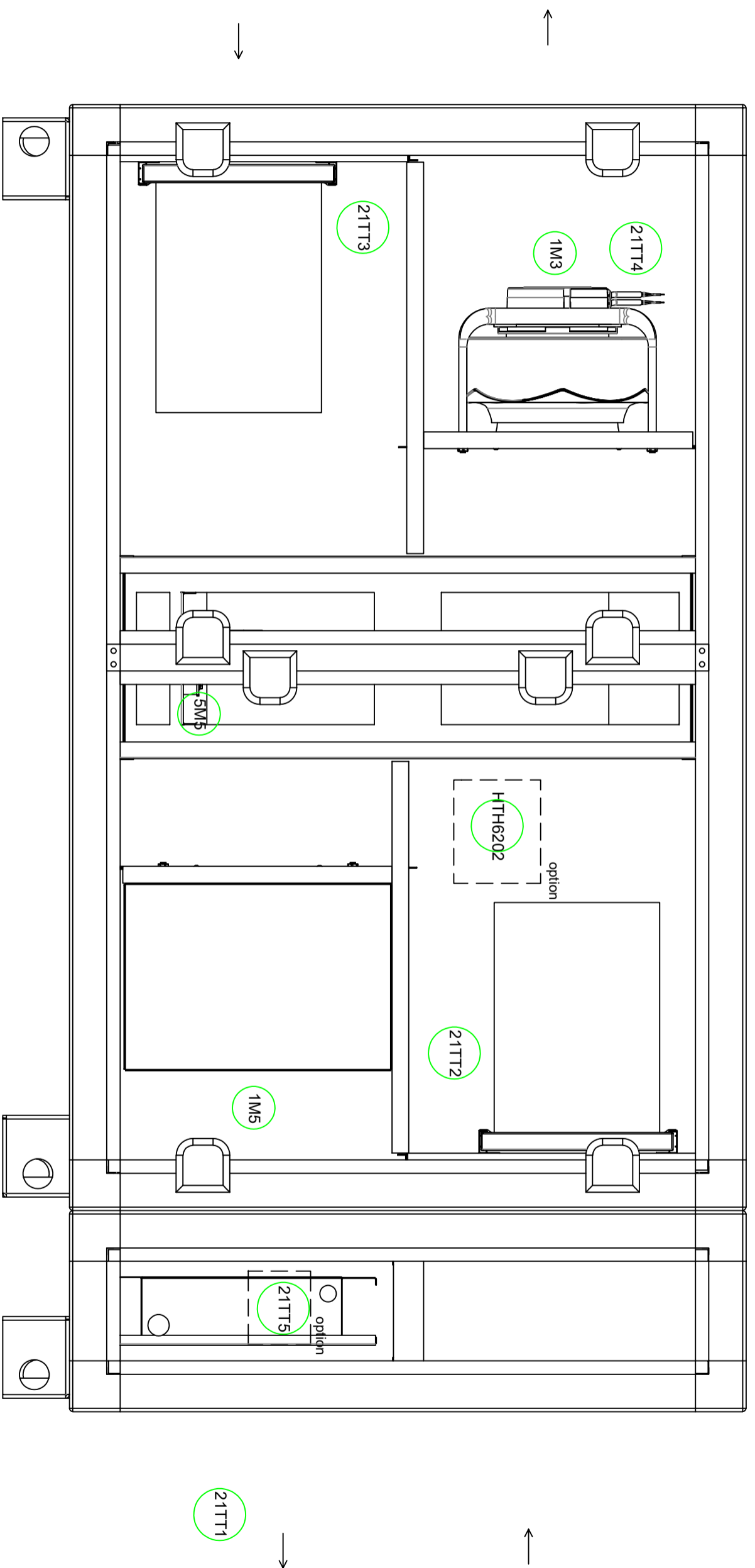

1WS1
H216
21A

HTH6202
option

①	Get.	HMV	Order	OJ Air2 master	unit drawing	Blz:	60
②	Datum	8-9-2020	Type	5			
③	-	-	Rev.	-			
④	-	-	status	-			

1

2

3

4

5

6

7

8

9

10

1WS1
H216
21A

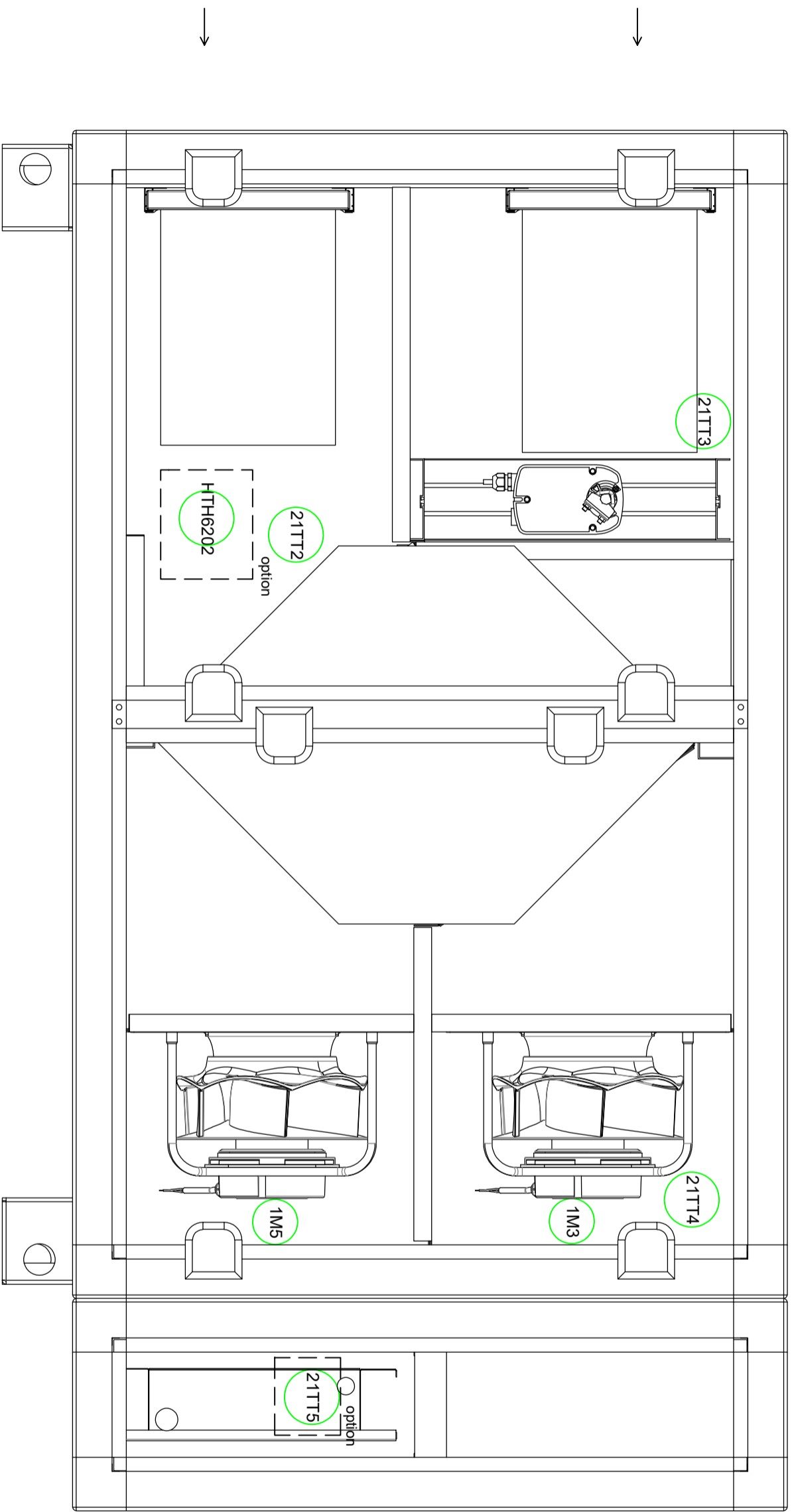

①	Get.	HMV
②	Datum	8-9-2020
③		

Order	OJ Air2 master
Type	
Rev.	5
status	-

unit drawing

Blz: **61**